



SUPERMARKET RANGE

WWW.ARCABOA.COM



COOLWORK®

CB



CE



Certificação / Certification / Certificat / Certificación

EN/IEC 60 335-1 EN/IEC 60 335-2-89 EN/IEC 62 223

EN/IEC 55014-1 EN/IEC 61000-3 ISO 23953-2



Rua do Lordelo 4510-591 Fânzeres – Portugal
 tlf: +351 22 489 68 20 / fax: +351 22 489 88 77
 e-mail: arcaboa@arcaboa.com / www.arcaboa.com



PT

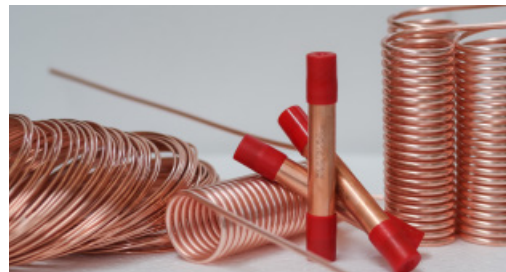

EN

ARCABOA - Indústria de Frio, S.A.
 Based in the parish of Fânzeres, Gondomar, 4 km from the city of Oporto, Arcaboa was founded on 13 January 1981 as a limited liability company.
 Our initial focus was the manufacture of domestic freezer model, but we soon moved on to manufacture a complete line of these products.

As time passed, we felt the need to extend our product range and in 1987 we designed a new line of refrigeration products for frozen food display.

We manufacture products for various brands and we also have our own brands "COOLWORK®", which have been marketed since the foundation of the company and is firmly established nationally and internationally.

Our main objective is to provide quality service. All our products are certified to European quality standards. Due to the company's growth, it became a public limited company in December 2000. We now have customers all over Europe and 80% of our sales are for export.

We are currently engaged in searching for new products within our field of manufacturing, in order to be able to offer improved working conditions to professionals in the catering and frozen food trade.
 We exist to provide quality products and service to our customers.

ARCABOA - Indústria de frio, s.a.,

Situada na freguesia de Fânzeres, concelho de Gondomar, a cerca de 4 Km da cidade do Porto, fundada em 13 de Janeiro de 1981 como sociedade por quotas.

Iniciámos a nossa actividade industrial com o fabrico de um modelo de arcas congeladoras domésticas, avançando rapidamente para uma linha completa destes produtos.

Com o decorrer do tempo sentimos a necessidade de aumentar a gama de produtos, o que nos estimulou, em meados de 1987, a uma nova projecção de produtos frigoríficos destinados à exposição de produtos alimentares congelados.

Fabricamos para várias marcas e temos também a nossa própria marca "COOLWORK®", que está no mercado desde a nossa fundação e implantada quer a nível nacional, quer a nível internacional. Para nós, servir com qualidade é o nosso objectivo. Todos os nossos produtos possuem certificações de qualidade no âmbito do Sistema Europeu de Qualidade. A empresa foi evoluindo e face ao seu desenvolvimento em Dezembro do ano 2000 transformou-se em sociedade anónima.

Actualmente possuímos clientes em toda a Europa e 80% do nosso volume de vendas destina-se à exportação. Hoje, a nossa filosofia é procurar novos produtos dentro da nossa área de fabrico, no sentido de oferecer outras condições de trabalho aos profissionais da indústria hoteleira e do comércio de alimentos congelados. Existimos para servir com qualidade e eficiência os nossos clientes.

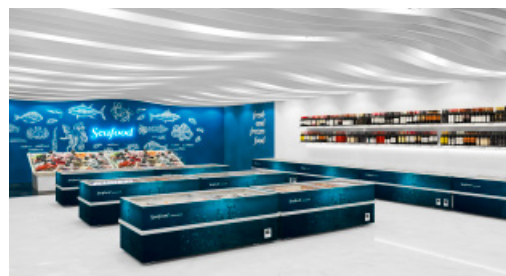

COOLWORK®

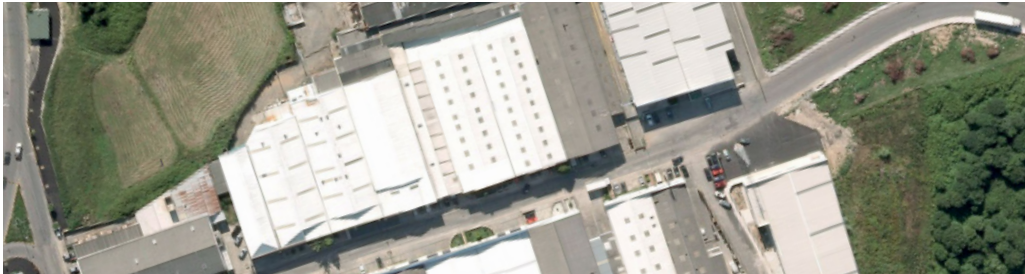

FR

ARCABOA - Indústria de frio, s.a.,
Située dans le village de Fânzeres, dans la région de Gondomar, à environ 4 Km de la ville de Porto, est une société spécialisée dans l'industrie du froid, qui a été créée le 13 Janvier 1981 en tant que société limitée. Nous avons débuté notre activité industrielle avec la fabrication d'un modèle de congélateurs domestiques et nous avons rapidement avancé vers une ligne complète de ces produits.

Avec le temps, nous avons senti le besoin d'augmenter notre gamme de produits, ce qui nous a conduit en 1987 à une nouvelle projection de produits frigorifiques destinés à l'exposition de produits alimentaires. Nous fabriquons pour plusieurs marques et nous avons également nos propres marques, "COOLWORK®", qui sont sur le marché depuis notre création et qui sont implantées aussi bien sur le plan national qu'international.

Notre objectif est de servir les clients en faisant preuve de qualité. Tous nos produits sont certifiés en termes de qualité dans le cadre du système de qualité européen. L'entreprise a évolué et, face à son développement, elle s'est transformée en société anonyme en décembre 2000.

Nous possédons actuellement des clients dans toute l'Europe et 80 % de notre total des ventes sont destinés à l'exportation. Aujourd'hui, nous avons pour philosophie de chercher de nouveaux produits dans notre secteur dans le but d'offrir de nouvelles conditions de travail aux professionnels de l'industrie hôtelière et du commerce de produits surgelés. Nous existons pour fournir des services et produits de qualité à nos clients.

DE

ARCABOA - Industria de frío, S.A.,
Das Unternehmen wurde in der Gemeinde Fânzeres, Kreis Gondomar - etwa 4 km von der nord-portugiesischen Metropole Porto entfernt gelegen - am 13. Januar 1981 als Gesellschaft mit beschränkter Haftung gegründet. Wir begannen unsere industrielle Tätigkeit mit der Herstellung einer Tiefkühltruhe für den Hausgebrauch. In der Folge wurde rasch eine komplette Produktlinie entwickelt.

Im Laufe der Zeit wurde die Produktpalette kontinuierlich erweitert: Mitte 1987 mit einer neuen Serie von Kühltruhen zur Lebensmittelpräsentation. Neben unserer eigenen Marke „COOLWORK“, die seit unserer Gründung auf dem Markt national und international eingeführt ist, produzieren für wir für eine ganze Reihe von verschiedenen Fremd-Marken.

Wir bieten Ihnen einen qualitativ hochwertigen Service an. Alle unsere Produkte sind nach dem europäischen Qualitätssystem zertifiziert. Das Unternehmen hat sich weiterentwickelt und wurde im Dezember 2000 in eine Aktiengesellschaft umgewandelt.

Wir beliefern derzeit Kunden in ganz Europa: 80% unserer Produktion gehen in den Export. Wir sind ständig bestrebt, neue Produkte zu entwickeln, um in der Hotellerie und im Tiefkühlhandel bessere Arbeitsbedingungen zu ermöglichen. Unser Motto ist: unsere Kunden mit Qualität zufrieden zu stellen.



CHV/V

750CHV/V / 900CHV/V / 1.100CHV/V
750CHV/2V / 900CHV/2V / 1.100CHV/2V



06



CEP

CEP 1.5 / CEP 2.0 /
CEP TOPO



10



PANORÂMICA

PANORÂMICA 2 /
PANORÂMICA TOPO



14



SUPER

SUPER 1.5 / SUPER 2.0 / SUPER 2.5 /
SUPER TOPO



22



DUPLA

DUPLA 2.2 / DUPLA TOPO



28



ARV

ARV 2.5



34

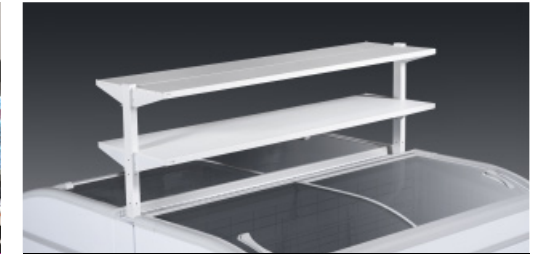

ACESSÓRIOS

ACCESSORIES / ACCESSOIRES / ZUBEHÖR



38





CHV-V / 2V

750 / 900 / 1.100

Expositor profesional para productos congelados / refrigerados

Professional freezer and chiller display

Congelateur et conservateur professionnel

Kühl- und tiefkühltruhen für professionelle warenpräsentation



750 CHV/2V



750 CHV/V



900 CHV/2V



900 CHV/V



1100 CHV/2V



1100 CHV/V

		750 CHV/V	750 CHV/V D	900 CHV/V	900 CHV/V D	1100 CHV/V	1100 CHV/V D
Technical Data							
Total Display Area (TDA)	m ²	1.1	1.1	1.5	1.5	1.7	1.7
Climatic class (EN23953)		3L1	3L1	3L1	3L1	3L1	3L1
Temperature range	°C	-18 / -25	-18 / -25	-18 / -25	-18 / -25	-18 / -25	-18 / -25
Maintenance free condenser		✓	✓	✓	✓	✓	✓
Visual alarm		○	✓	○	✓	○	✓
HACCP - Hazard analysis and critical control points		○	✓	○	✓	○	✓
Surveillance system LON-RS485		-	○	-	○	-	○
Net volume	lt	459	459	652	652	805	805
Gross volume	lt	597	597	839	839	1032	1032
Electrical Data							
Voltage/Frequency	V/Hz	230/50	230/50	230/50	230/50	230/50	230/50
Rated Power	W	345	345	345	345	345	345
Rated Current	A	2.5	2.5	2.5	2.5	2.5	2.5
Energy Consumption	kWh/24h	3.9	4.5	4.5	5.4	4.9	5.4
Energy Efficiency Index (EEI)		23.8	27.4	21.8	25.8	20.5	22.6
Refrigerant Data							
Refrigerant type		R290	R290	R290	R290	R290	R290
Number of compressors		2	2	2	2	2	2
Maximum operating pressure	bar	30	30	30	30	30	30
Dimensions and Weight Data							
Cabinet dimensions	mm	1550x960x780	1550x960x780	2050x960x780	2050x960x780	2500x960x780	2500x960x780
Packaging dimension	mm	1640x1030x840	1640x1030x840	2140x1030x840	2140x1030x840	2590x1030x840	2590x1030x840
Net weight	kg	81	81	105	105	125	125
Gross weight	kg	137	137	160	160	200	200

○ OPCIONAL | OPTIONAL | FACULTATIF | OPTIONAL ✓ SIM | YES | OUI | JA;

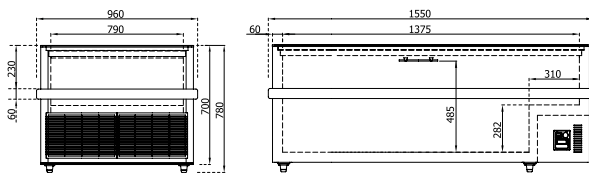

750 CHV/V

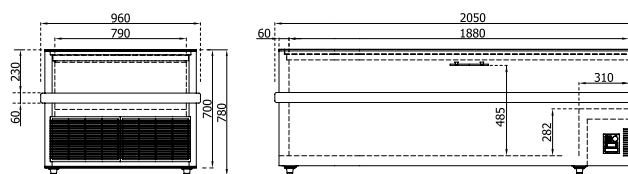

900 CHV/V

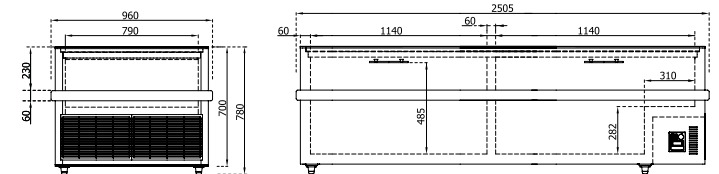

1100 CHV/V



ISO: 23 953-1-2

EN 60 335-2-89 | EN 60 335-1



www.arcaboa.com

CHV-V / 2V





CEP

CEP 1.5 / CEP 2.0 / CEP TOPO

Expositor profesional para productos congelados / refrigerados

Professional freezer and chiller display

Congelateur et conservateur professionnel

Kühl- und tiefkühltruhen für professionelle warenpräsentation



CEP 1.5 VCI



CEP 1.5 VLC



CEP 2.0 VCI



CEP 2.0 VLC



CEP TOPO

		CEP 1.5	CEP 1.5 D	CEP 2.0	CEP 2.0 D	CEP TOPO D
Technical Data						
Total Display Area (TDA)	m ²	0.8	0.8	1.1	1.1	0.8
Climatic class (EN23953)		3L1	3L1	3L1	3L1	3L1
Temperature range	°C	-18 / -22	-18 / -22	-18 / -22	-18 / -22	-18 / -22
Maintenance free condenser		✓	✓	✓	✓	✓
Visual alarm		✓	✓	✓	✓	✓
HACCP - Hazard analysis and critical control points		✓	✓	✓	✓	✓
Surveillance system LON-RS485		-	○	-	○	○
Net volume	lt	350	350	518	518	370
Gross volume	lt	492	492	712	712	520
Electrical Data						
Voltage/Frequency	V/Hz	220/50	220/50	220/50	220/50	220/50
Rated Power	W	526	526	526	526	574
Rated Current	A	3.8	3.8	3.8	3.8	3.1
Energy Consumption	kWh/24h	7.5	8.2	8.4	9.0	9.0
Energy Efficiency Index (EEI)		57.6	63.0	51.5	55.2	65.2
Refrigerant Data						
Refrigerant type		R290	R290	R290	R290	R290
Number of compressors		2	2	2	2	2
Maximum operating pressure	bar	30	30	30	30	30
Dimensions and Weight Data						
Cabinet dimensions	mm	1500x880x940	1500x880x940	2000x880x940	2000x880x940	1770x840x900
Packaging dimension	mm	1630x970x1090	1630x970x1090	2150x970x1090	2150x970x1090	1920x970x1090
Net weight	kg	VCI: 98 ; VLC: 100	VCI: 98 ; VLC: 100	VCI: 123 ; VLC: 125	VCI: 123 ; VLC: 125	100
Gross weight	kg	VCI: 159 ; VLC: 171	VCI: 159 ; VLC: 171	VCI: 186 ; VLC: 193	VCI: 186 ; VLC: 193	187

○ OPCIONAL | OPTIONAL | FACULTATIF | OPTIONAL ✓ SIM | YES | OUI | JA;

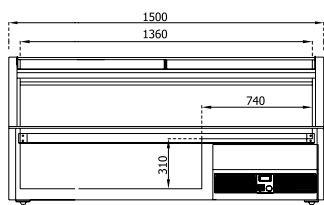

CEP 1.5

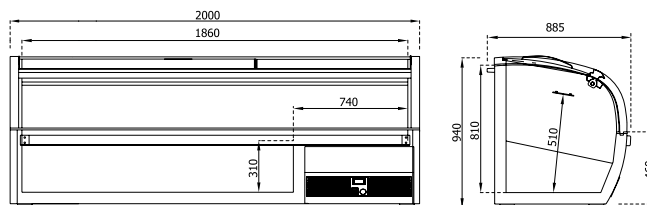

CEP 2.0

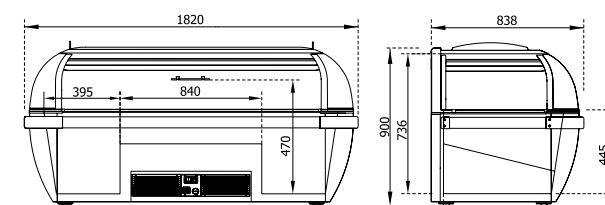

CEP TOPO



CB



[-15/-18]



[+5/-1]



www.arcaboa.com

**CEP 2.0 D
& CEP TOPO D**



PANORÂMICA

PANORÂMICA 2.0 DE
PANORÂMICA TOPO DE

Expositor profissional para produtos congelados / refrigerados

Professional freezer and chiller display

Congelateur et conservateur professionnel

Kühl- und tiefkühltruhen für professionelle warenpräsentation



PANORÂMICA 2.0 DE



PANORÂMICA TOPO DE

		PANORÂMICA 2.0DE	PANORÂMICA 2.0DEPN	PANORÂMICA TOPO DE	PANORÂMICA TOPO DEPN
Technical Data					
Total Display Area (TDA)	m ²	1.4	1.4	1.4	1.4
Climatic class (EN23953)		3L1	3L1 / 3M1	3L1	3L1 / 3M1
Temperature range	°C	-18 / -25	+15 / -25	-18 / -25	+15 / -25
Maintenance free condenser		✓	✓	✓	✓
Visual alarm		✓	✓	✓	✓
HACCP - Hazard analysis and critical control points		✓	✓	✓	✓
Surveillance system LON-RS485		○	○	○	○
Net volume	lt	670	670	450	450
Gross volume	lt	890	890	620	620
Electrical Data					
Voltage/Frequency	V/Hz	220-240/50	220-240/50	220-240/50	220-240/50
Rated Power	W	662	777	643	771
Rated Current	A	4.4	5.7	4.2	5.1
Energy Consumption	kWh/24h	6.2	7,5(-) / 3,3(+)	6.3	8,7(-) / 4,5(+)
Energy Efficiency Index (EEI)		29.1	35.0	33.1	27.7
Refrigerant Data					
Refrigerant type		R290	R290	R290	R290
Number of compressors		2	2	2	2
Maximum operating pressure	bar	30	30	30	30
Dimensions and Weight Data					
Cabinet dimensions	mm	2020x920x830	2020x920x830	1965x920x830	1965x920x830
Packaging dimension	mm	2110x1020x950	2110x1020x950	2080x1030x950	2080x1030x950
Net weight	kg	127	127	120	120
Gross weight	kg	170	170	162	162

○ OPCIONAL | OPTIONAL | FACULTATIF | OPTIONAL ✓ SIM | YES | OUI | JA



CB

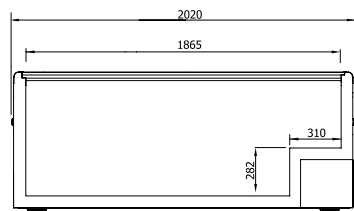

PANORÂMICA 2.0

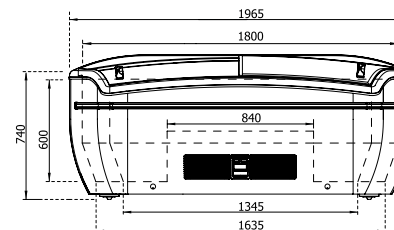
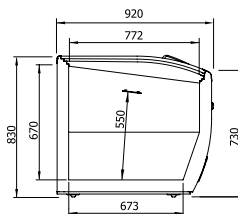

PANORÂMICA TOPO

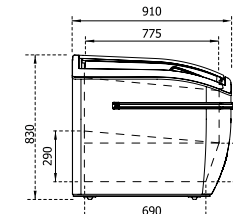

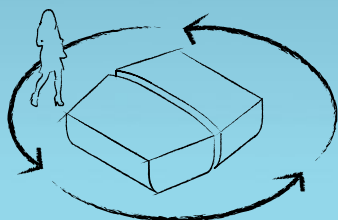

PT

Características gerais

Versões disponíveis:
(DE) congelador com descongelação automática e evaporação de água (DPN) congelador/conservador com descongelação automática;

Interior e exterior em chapa galvanizada revestida a PVC de acordo com normativas alimentares;

Evaporador, condensador e todo o circuito de frio em cobre;
Condensador livre de manutenção;
2 grupos frigoríficos de elevado rendimento (COP) e baixa emissão térmica;

Alta eficiência energética e baixos custos de operação;
Gás refrigerante R290;
Descongelação automática por gás quente nos modelos DE e DEPN;

Iluminação LED;
Personalização.

EN

General features

Versions available:
(DE) freezer with automatic defrost with water evaporation
(DEPN) freezer/chiller with automatic defrost;

Internal and external nontoxic PVC coated hot galvanized steel according to the food regulations;

Evaporador, condenser and all tubes in cooper;
Free maintenance condenser;
2 high efficiency cooling groups (COP) and low thermic emission;

High energy efficiency and low operation costs;
Refrigerant gas R290;
Automatic defrost by hot gas on models DE and DEPN;

LED lighting;
Customization.

FR

Caractéristiques générales

Versions disponibles:
(DE) Congélateur avec dégivrage automatique et évaporation de l'eau (DEPN) congélateur / refroidisseur avec dégivrage automatique et évaporation de l'eau;

Intérieur et extérieur en tôle galvanise avec revêtement atoxique en PVC et d'accord réglementations alimentaires;

Evaporateur, condenseur et tubes en cuivre; Condenseur sans maintenance; 2 groupes frigorifiques de grand efficacité (COP) et faibles émission thermique;

Grand efficacité d'énergie et faible coûts de fonctionnement;
Réfrigérant R290;
Dégivrage automatique par gaz chaud sur les modèles DE et DEPN;

Éclairage LED;
Personnalisation.

DE

Allgemeine merkmale

Verfügbar in 2 Versionen:
(DE) Tiefkühltruhe mit automatischer Abtauung und Wasserverdampfung (DEPN) Tiefkühltruhe / Kühltruhe mit automatischer Abtauung und Wasserverdampfung;

Innen- und Außenseite aus lebensmittelechtem, PVC-beschichtetem Stahlblech, gemäß CE 1935/2004;

Gesamter Kältekreislauf, inklusive Verdampfer und Kondensator aus Kupfer; Wartungsfreier Kondensator; 2 Kälteaggregate mit hoher Leistungszahl (COP) und geringer Wärmestrahlung;

Hohe Energieeffizienz und niedrige Betriebskosten; Kältemittel R290; Automatische Heißgasabtauung bei DE und DEPN-Modellen;

LED-Beleuchtung;
Individuell anpassbar.

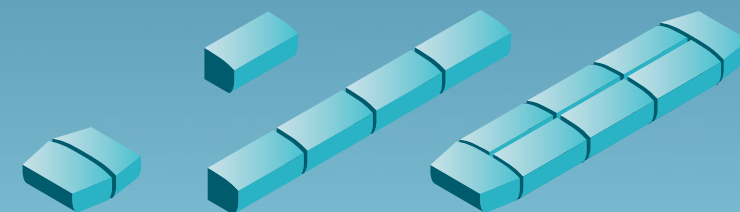

Stand alone / Back to back / Line up / Island



CB





PT

Soluções Modulares

Ilhas de grande eficiência e flexibilidade para promoção de productos conservados e congelados.

EN

Modular Solutions

Efficient and flexible plug-in island for promoting frozen and chilled food.

FR

Solution Modulaire

Îlot plug-in de grand efficace et flexibilité pour la promotion des produits alimentaires surgelés et réfrigérés.

DE

Modular Lösungen

Hoch effiziente und flexile Inseln zur verkaufsfördernden Präsentation von Kühl- und Tiefkühlprodukten.

 SUPERMARKET
RANGE

COOLWORK®



**PANORÂMICA 2.0 DE
6 TOPO DE**

 **arcaboa**
pure freezers, pure quality

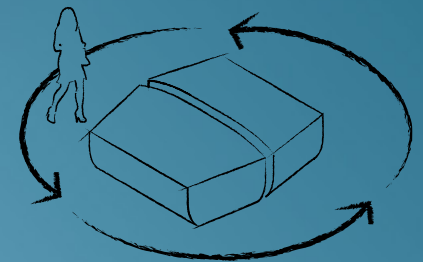



PT

Personalização

No modelo PANORÂMICA tem a possibilidade de escolher a cor do perfil antichoque bem como da cor da chapa exterior para que personalize o produto de acordo com a imagem corporativa que se pretende.

EN

Customization

In the PANORÂMICA model you can choose the color of the bumper as well the color of the outer steel to customize the product accordingly to the desired corporate image.

FR

Customisation

Dans le modèle PANORÂMICA, es possible choisir la couleur du profil anticadie ainsi la couleur de la plaque extérieure pour personnalisation le produit en fonction de l'image de marque souhaitée.

DE

Anpassung

Beim PANORÂMICA Modell können Farbe der Stoßschutzleistesowie der Außenwände gewählt werden, um das Produkt dem Firmenimage anzupassen.

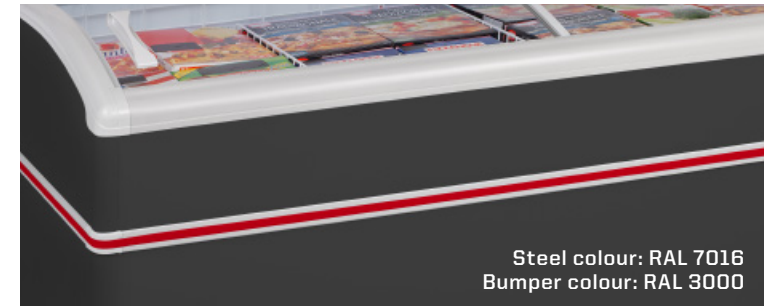



BIO

FROZENFOOD



SUPER

1.5 / 2.0 / 2.5 / TOPO

Expositor profesional para productos congelados / refrigerados

Professional freezer and chiller display

Congelateur et conservateur professionnel

Expositor profesional para congelados y enfriados



SUPER 1.5



SUPER 2.0



SUPER TOPO



SUPER 2.5

		SUPER 1.5 DE	SUPER 1.5 DEPN	SUPER 2.0 DE	SUPER 2.0 DEPN	SUPER 2.5 DE	SUPER 2.5 DEPN	SUPER TOPO DE	SUPER TOPO DEPN
Technical Data									
Total Display Area (TDA)		0.9	0.9	1.29	1.29	1.66	1.66	1.38	1.38
Climatic class (EN23953)		3L1	3L1 / 3M1	3L1	3L1 / 3M1	3L1	3L1 / 3M1	3L1	3L1 / 3M1
Temperature range	°C	-18 / -25	+15 / -25	-18 / -25	+15 / -25	-18 / -25	+15 / -25	-18 / -25	+15 / -25
Maintenance free condenser		✓	✓	✓	✓	✓	✓	✓	✓
EC fan motor		○	○	○	○	○	○	○	○
Visual alarm		✓	✓	✓	✓	✓	✓	✓	✓
Sound alarm		○	○	○	○	○	○	○	○
HACCP - Hazard analysis and critical control points		✓	✓	✓	✓	✓	✓	✓	✓
Surveillance system LON-RS485		○	○	○	○	○	○	○	○
Net volume	lt	400	400	580	580	750	750	430	430
Gross volume	lt	590	590	800	800	1030	1030	540	540
Electrical Data									
Voltage/Frequency	V/Hz	220-240/50	220-240/50	220-240/50	220-240/50	220-240/50	220-240/50	220-240/50	220-240/50
Rated Power	W	644	759	662	777	681	796	656	771
Rated Current	A	4.2	5.0	4.4	5.1	4.5	5.2	4.3	5.1
Energy Consumption	kWh/24h	6.0	7,3(-) / 3,3(+)	6.2	7,5(-) / 3,3(+)	7.4	8,3(-) / 4,0(+)	6.3	8,3(-) / 4,1(+)
Energy Efficiency Index (EEI)		35.9	49.6	32.6	39.2	31.9	35.6	31.2	42.7
Refrigerant Data									
Refrigerant type		R290	R290	R290	R290	R290	R290	R290	R290
Number of compressors		2	2	2	2	2	2	2	2
Refrigerant gas charge	kg	2 x 0,60	2 x 0,60	2 x 0,60	2 x 0,60	2 x 0,80	2 x 0,90	2 x 0,60	2 x 0,60
Maximum operating pressure	bar	30	30	30	30	30	30	30	30
Dimensions and Weight Data									
Cabinet dimensions	mm	1520x920x790	1520x920x790	2020x920x790	2020x920x790	2500x920x790	2500x920x790	1990x920x790	1990x920x790
Packaging dimension	mm	1610x1020x850	1610x1020x850	2110x1020x850	2110x1020x850	2610x1020x850	2610x1020x850	2090x1020x850	2090x1020x850
Net weight	kg	98	98	127	127	147	147	120	120
Gross weight	kg	141	141	168	168	198	198	160	160



○ OPCIONAL | OPTIONAL | FACULTATIF | OPTIONAL
 ✓ SIM | YES | OUI | JA; × NÃO | NO | NON | NEIN;

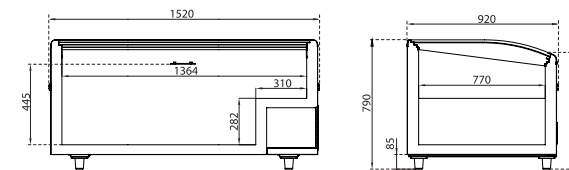

SUPER 1.5



www.arcaboa.com

**SUPER 2.0 DE
SUPER TOPO DE**

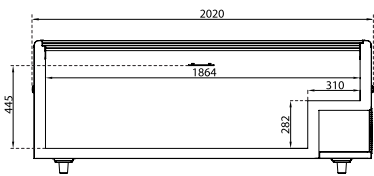

SUPER 2.0

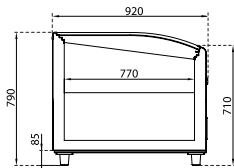

SUPER 2.5

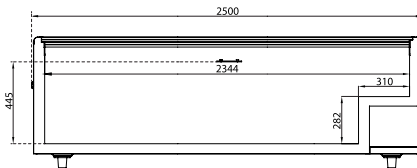

SUPER TOPO

**SUPER 2.5 DE +
SUPER TOPO DE**

26

WWW.ARCABOA.COM

 **SUPERMARKET
RANGE**

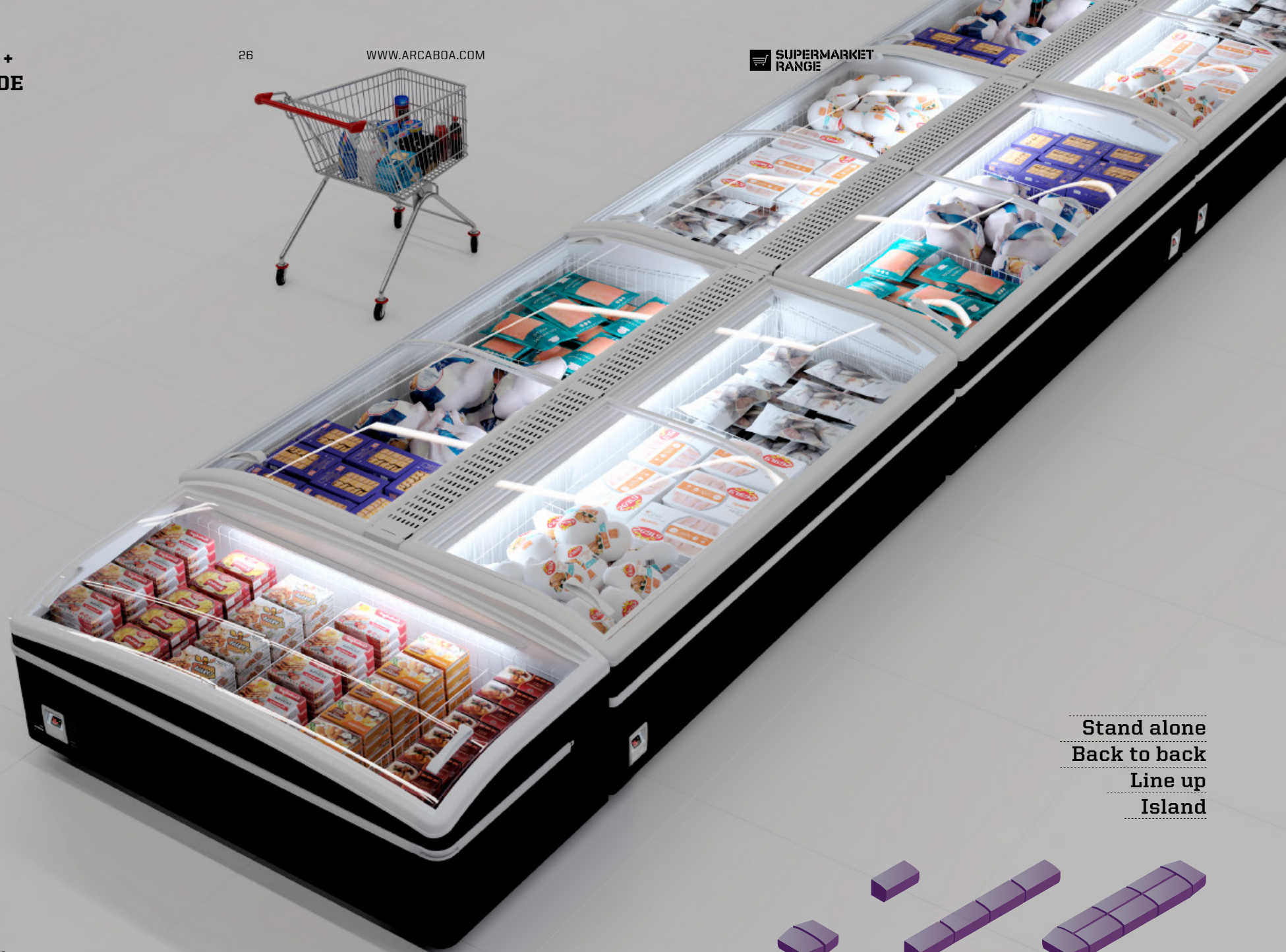

Stand alone
Back to back
Line up
Island

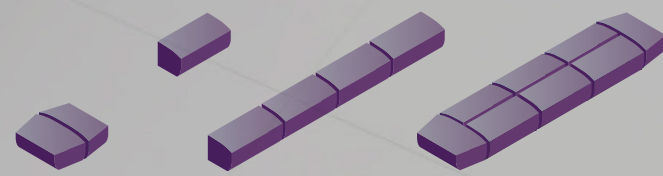

COOLWORK®



PT

Personalização

No modelo SUPER tem a possibilidade de escolher a cor do perfil antichoque bem como da cor da chapa exterior para que personalize o produto de acordo com a imagem corporativa que se pretende.

EN

Customization

In the SUPER model you can choose the color of the bumper as well the color of the outer steel to customize the product accordingly to the desired corporate image.

FR

Customisation

Dans le modèle SUPER, es possible choisir la couleur du profil anticadée ainsi la couleur de la plaque extérieure pour personnalisation le produit en fonction de l'image de marque souhaitée.

DE

Anpassung

Beim SUPER Modell können Farbe der Stoßschutzleistesowie der Außenwände gewählt werden, um das Produkt dem Firmenimage anzupassen.



Steel colour: RAL 9005
Bumper colour: RAL 9005

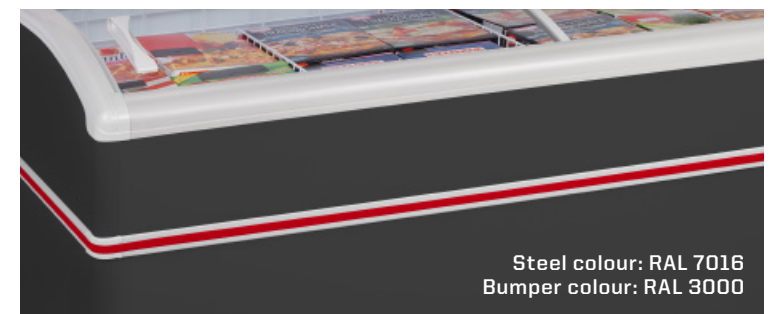

Steel colour: RAL 7016
Bumper colour: RAL 3000

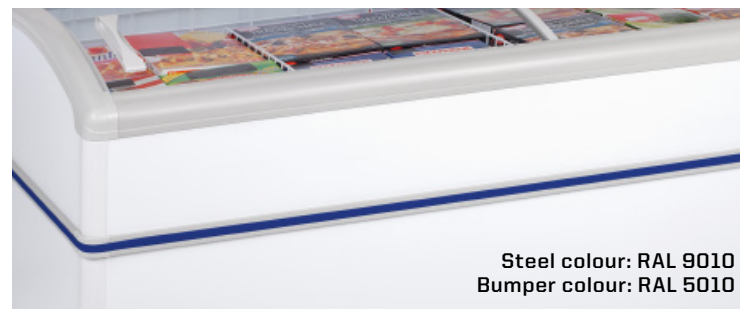

Steel colour: RAL 9010
Bumper colour: RAL 5010



Steel image: PHOTO PRINTING





DUPLA

2,2 DE / TOPO DE

Expositor profesional para productos congelados / refrigerados

Professional freezer and chiller display

Congelateur et conservateur professionnel

Kühl- und tiefkühltruhen für professionelle warenpräsentation



DUPLA 2.2 DE



DUPLA TOPO DE

		DUPLA 2.2 DE	DUPLA 2.2 DEPN	DUPLA TOPO DE	DUPLA TOPO DEPN
Technical Data					
Total Display Area (TDA)	m ²	2.7	2.7	0.7	0.7
Climatic class (EN23953)		3L1	3M1 / 3L1	3L1	3M1 / 3L1
Temperature range	°C	-18 / -22	+15 / -22	-18 / -22	+15 / -22
Maintenance free condenser		✓	✓	✓	✓
Visual alarm		✓	✓	✓	✓
HACCP - Hazard analysis and critical control points		✓	✓	✓	✓
Surveillance system LON-RS485		○	○	○	○
Net volume	lt	1255	1255	334	334
Gross volume	lt	1697	1697	425	425
Electrical Data					
Voltage/Frequency	V/Hz	220/50	220/50	220/50	220/50
Rated Power	W	672	672	387	484
Rated Current	A	3.1	4.5	1.8	3.0
Energy Consumption	kWh/24h	9.2	9,2(-) / 4,6(+)	4.1	4,1(-) / 2,0(+)
Energy Efficiency Index (EEI)		26,7	26,7	34,9	34,9
Refrigerant Data					
Refrigerant type		R290	R290	R290	R290
Number of compressors		2	2	1	1
Maximum operating pressure	bar	30	30	30	30
Dimensions and Weight Data					
Cabinet dimensions	mm	2150x1465x930	2150x1465x930	1470x811x902	1470x811x902
Packaging dimension	mm	2240x1550x1050	2240x1550x1050	1530x920x1000	1530x920x1000
Net weight	kg	198	198	85	85
Gross weight	kg	251	251	125	125



○ OPCIONAL | OPTIONAL | FACULTATIF | OPTIONAL ✓ SIM | YES | OUI | JA;

REGISTERED COMMUNITY DESIGN

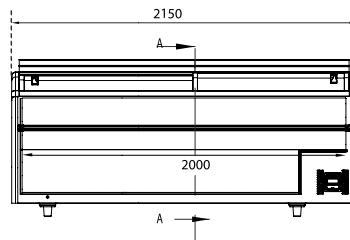

DUPLA 2.2

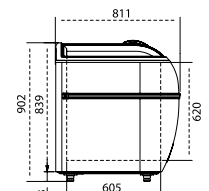
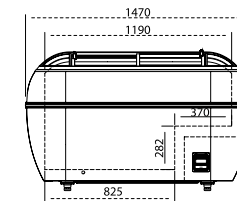
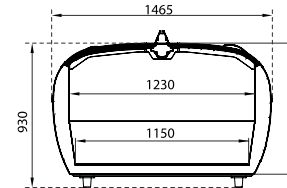

DUPLA TOPO



DUPLA
New concept
Small on the outside,
big on the inside.

www.arcaboa.com

**DUPLA 2.0 DE
DUPLA TOPO DE**

32

WWW.ARCABOA.COM

DUPLA
New concept
 Small on the outside,
 big on the inside.

COOLWORK®



FÁCIL INSTALAÇÃO
EASY PLUG-IN
 INSTALLATION FACILE
EINFACHES INSTALLATION



SEM MANUTENÇÃO
MAINTENANCE FREE
 SANS ENTRETIEN
WARTUNGSFREI



DESIGN ERGONÓMICO E ÚNICO
UNIQUE AND ERGONOMIC DESIGN
 DESIGN ERGONOMIQUE ET UNIQUE
EXKLUSIVES UND ERGONOMISCHES DESIGN



REDUZIDA ÁREA DE OCUPAÇÃO
LOW FLOOR AREA OCCUPATION
 ENCOMBREMENT RÉDUIT
REDUZIESTE STANDFLÄCHE



DESIGN REGISTRADO Nº 002365890-0001
REGISTERED DESIGN NO. 002365890-0001
 NUMÉRO DE MODÈLE ENREGISTRÉ 002365890-0001
GERAUCHSMUSTER NUMMER 002365890-0001



ALTA PERFORMANCE A BAIXO CUSTO
HIGH PERFORMANCE AT LOW COST OPERATION
 HAUTE PERFORMANCE À FAIBLE COÛT
HOHE LEISTUNG BEI GERINGEN KOSTEN



ILUMINAÇÃO LED DUPLO
DOUBLE LED LIGHTING
 DOUBLE ÉCLAIRAGE LED
DOPPELTE LED-BELEUCHTUNG



BAIXO CONSUMO ENERGÉTICO
LOW POWER CONSUMPTION
 FAIBLE CONSOMMATION ÉNERGÉTIQUE
GERINGER ENERGIEVERBRAUCH

 **arcaboa**
 pure freezers, pure quality

PT

**CARACTERÍSTICAS GERAIS:
DUPLA 2.2 D**

- Versões disponíveis**
- (DE) congelador com descongelação automática e evaporação de água;
 - (DPN) congelador / conservador com descongelação automática;
 - Interior e exterior em chapa galvanizada revestida a PVC de acordo com normativas alimentares;
 - Evaporador, condensador e todo o circuito de frio em cobre;
 - Condensador livre de manutenção;
 - 2 grupos frigoríficos de elevado rendimento (COP) e baixa emissão térmica;
 - Alta eficiência energética e baixos custos de operação;
 - Gás refrigerante R290;
 - Descongelação automática por gás quente nos modelos DE e DEPN;
 - Fundo falso ajustável em altura nos modelos DE e DEPN;
 - Iluminação dupla LED;
 - Personalização.

EN

**GENERAL FEATURES:
DUPLA 2.2 D**

- Versions available:**
- (DE) freezer with automatic defrost with water evaporation;
 - (DEPN) freezer/chiller with automatic defrost;
 - Internal and external nontoxic -PVC coated hot galvanized steel according to the food regulations;
 - Evaporador, condenser and all tubes in cooper;
 - Free maintenance condenser;
 - 2 high efficiency cooling groups (COP) and low thermic emission;
 - High energy efficiency and low operation costs;
 - Refrigerant gas R290;
 - Automatic defrost by hot gas on models DE and DEPN;
 - False adjustable bottom on models DE and DEPN;
 - LED lighting;
 - Customization.

FR

**CARACTÉRISTIQUES GÉNÉRALES:
DUPLA 2.2 D**

- Versions disponibles:**
- (DE) Congélateur avec dégivrage automatique et évaporation de l'eau;
 - (DEPN) congélateur / refroidisseur avec dégivrage automatique et évaporation de l'eau;
 - Intérieur et extérieur en tôle galvanise avec revêtement atoxique en PVC et d'accord réglementations alimentaires;
 - Evaporateur, condenseur et tubes en cuivre;
 - Condenseur sans maintenance;
 - 2 groupes frigorifiques de grand efficience (COP) et faibles émission thermique;
 - Grand efficience d'énergie et faible coûts de fonctonnement;
 - Réfrigérant R290;
 - Dégivrage automatique par gaz chaud sur les modèles DE et DEPN;
 - Faux fond réglable sur les modèles DE et DEPN;
 - Éclairage double LED;
 - Personnalisation.

DE

**GENERAL FEATURES:
DUPLA 2.2 D**

- Verfügbar in 2 Versionen**
- (DE) Tiefkühltruhe mit automatischer Abtaung und Wasserverdampfung;
 - (DEPN) Tiefkühltruhe / Kühltruhe mit automatischer Abtaung und Wasserverdampfung;
 - Innen- und Außenseite aus lebensmittelechtem, PVC-beschichtetem Stahlblech, gemäß CE 1935/2004;
 - Gesamter Kältekreislauf, inklusive - Verdampfer und Kondensator aus Kupfer;
 - Wartungsfreier Kondensator;
 - 2 Kälteaggregate mit hoher - Leistungszahl (COP) und geringer Wärmestrahlung;
 - Hohe Energieeffizienz und niedrige Betriebskosten;
 - Kältemittel R290.
 - Automatische Heißgasabtaung bei DE- und DEPN-Modellen.
 - Höhenverstellbarer falscher Boden - bei DE- und DEPN-Modellen.
 - 2 LED-Beleuchtung
 - Individuell anpassbar

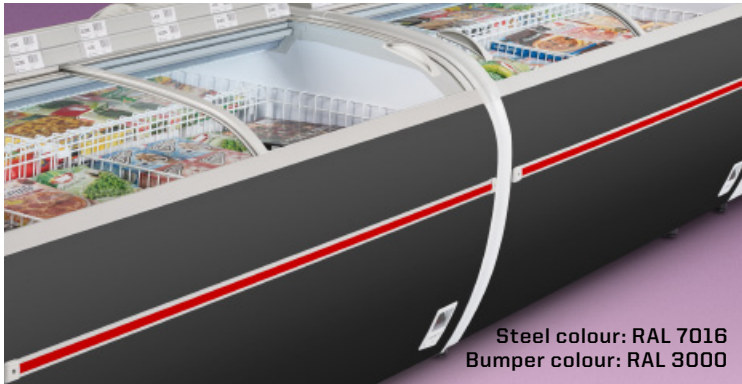

PT

Personalização

No modelo SUPER tem a possibilidade de escolher a cor do perfil antichoque bem como da cor da chapa exterior para que personalize o produto de acordo com a imagem corporativa que se pretende.

EN

Customization

In the SUPER model you can choose the color of the bumper as well the color of the outer steel to customize the product accordingly to the desired corporate image.

FR

Customisation

Dans le modèle SUPER, es possible choisir la couleur du profil anticadie ainsi la couleur de la plaque extérieure pour personnalisation le produit en fonction de l'image de marque souhaitée.

DE

Anpassung

Beim SUPER Modell können Farbe der Stoßschutzleistesowie der Außenwände gewählt werden, um das Produkt dem Firmenimage anzupassen.



ARV

ARV 2.5

Expositor profesional para productos congelados / refrigerados

Professional freezer and chiller display

Congelateur et conservateur professionnel

Kühl- und tiefkühltruhen für professionelle warenpräsentation



ARV 2.5 + SUPER 2.5

MODEL:

ARV





**SUPERMARKET
RANGE**

FROZEN FOOD

arcaboa
pure freezers, pure quality



ARV 2.5 TOP		
Technical Data		
Total Display Area (TDA)	m ²	1.7
Climatic class (EN23953)		3L1
Temperature range	°C	-18 / -23
Maintenance free condenser		✓
Visual alarm		✓
HACCP - Hazard analysis and critical control points		✓
Surveillance system LON-RS485		○
Self-closing doors		✓
Adjustable shelves		8
Net volume	lt	642
Gross volume	lt	760
Electrical Data		
Voltage/Frequency	V/Hz	220/50
Rated Power	W	1100
Rated Current	A	6
Refrigerant Data		
Refrigerant type		R290
Number of compressors		2
Maximum operating pressure	bar	30
Dimensions and Weight Data		
Cabinet dimensions	mm	2500x880x940
Packaging dimension	mm	2660x1060x1670
Net weight	kg	462
Gross weight	kg	542

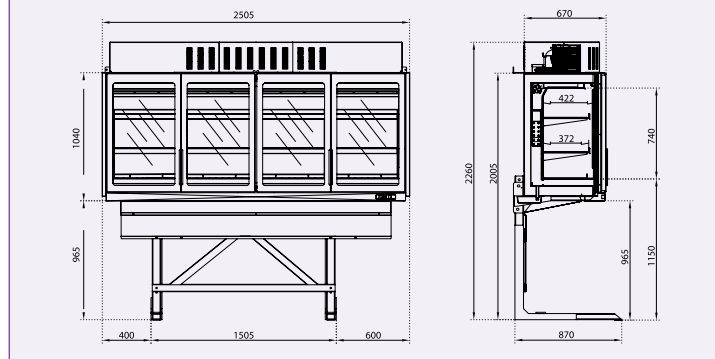

○ OPTIONAL | OPTIONAL | FACULTATIF | OPTIONAL ✓ SIM | YES | OUI | JA



ARV 2.5











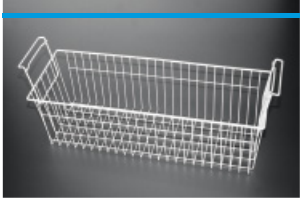

www.arcaboa.com

**ARV 2.5 TOP
SUPER 2.5 DE**

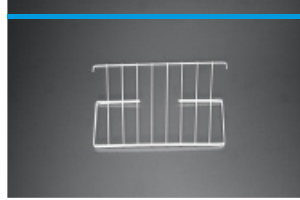
Accessórios

Accessories / Accessoires / Zubehör

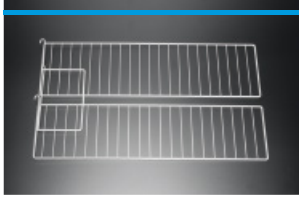
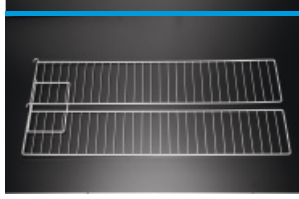
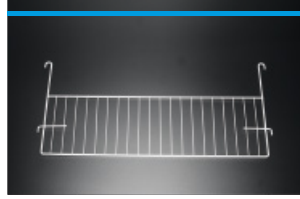
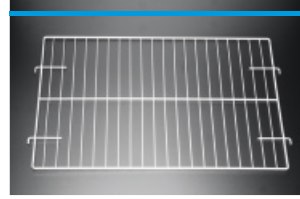











	<p>REF: AR 050</p> 	<p>REF: AR 070</p> 	<p>REF: AR 080</p> 	<p>REF: AR 085</p> 	<p>REF: PL 155</p> 	<p>REF: PI 800 / PI 801 / PI 803</p> 
<p>Descrição Description Description Beschreibung</p> <p>REF/Modelo compatível REF/Compatible model REF / Modèle compatible REF / kompatibles Modell</p>	<p>Cesto Basket Panier Korb</p> <p>AR 050: 750 900 1100 > CHV/V</p>	<p>Cesto Basket Panier Kleines Korb</p> <p>AR 070: 750 900 1100 > CHV/2V</p>	<p>Cesto aplicação de PI500, PI501 e PI502 Basket use with PI500, PI501 e PI502 Panier application avec PI500, PI501 PI502 Rorb von PI500, PI501, PI502</p> <p>AR 080: 750 900 1100 > CHV/V</p>	<p>Divisória de cesto Basket divider Séparateur pour panier Trenngitter für Korb.</p> <p>AR 085: AR 050 AR 070 AR 080</p>	<p>Cuba plástica Plastic container Cuve plastique Kunststoffbehälter.</p> <p>PL 155: AR 050 AR 070 AR 080</p>	<p>Kit de iluminação LED LED kit Eclairage LED LED Beleuchtungsset.</p> <p>PI 800 >> 750 CHV/V / CHV/2V PI 801 >> 900 CHV/V / CHV/2V PI 803 >> 1100 CHV/V / CHV/2V</p>
	<p>REF: PI 500 / PI 501 / PI 502</p> 	<p>REF: AR 094</p> 	<p>REF: AR 095</p> 	<p>REF: AR 096</p> 	<p>REF: AR 097</p> 	<p>REF: PI 113 / PI 114 / PI 115</p> 
<p>Descrição Description Description Beschreibung</p> <p>REF/Modelo compatível REF/Compatible model REF / Modèle compatible REF / kompatibles Modell</p>	<p>Tubo de suporte longitudinal Lengthwise bar holder Tube de support longitudinal Vierkantrrohr zur Längsunterstützung</p> <p>PI 500 >> 750 CHV/V PI 501 >> 900 CHV/V PI 502 >> 1100 CHV/V</p>	<p>Divisória Divider Séparateur Trenngitter</p> <p>AR 094 >> CHV/V CHV/2V</p>	<p>Divisória Divider Séparateur Trenngitter</p> <p>AR 095 >> CHV CHV/2V</p>	<p>Divisória baixa Low divider Séparateur bas Kleines Trenngitter</p> <p>AR 096 >> CHV/V CHV/2V</p>	<p>Divisória alta High divider Séparateur haut Großes Trenngitter.</p> <p>AR 097 >> CHV/V CHV/2V</p>	<p>Perfil expositor de preços Ticket strip Porte-prix Preisauszeichnungsleiste.</p> <p>PI 113 >> 750 CHV/V / CHV/2V PI 114 >> 900 CHV/V / CHV/2V PI 115 >> 1100 CHV/V / CHV/2V</p>

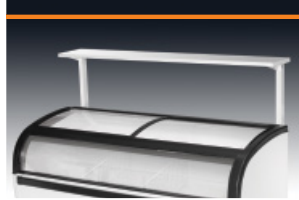

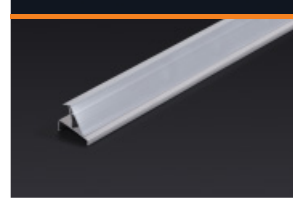
Accessórios

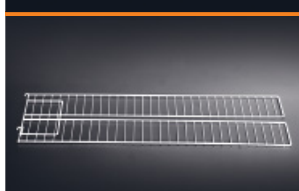
Accessories / Accessoires / Zubehör

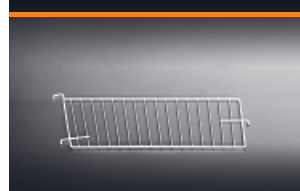

	<p>REF: PI 321 / PI 313</p> 	<p>REF: PI 320 \ PI 325</p> 	<p>REF: PI 311 \ PI 315</p> 	<p>REF: PI 310 \ PI 335</p> 	<p>REF: AR 032 / PL 155 / AR 085</p> 	<p>REF: PI 100 / PI 110</p> 
<p>Descrição Description Description Beschreibung</p> <p>REF/Modelo compatível REF/Compatible model REF / Modèle compatible REF / kompatibles Modell</p>	<p>Kit de prateleira - 2 duplas Shelf kit - 2 double Kit de étagère - 2 double Set Regalaufsatz - 2 Doppelregale.</p> <p>PI 313 >> CEP 1.5 PI 321 >> CEP 2.0</p>	<p>Kit prateleira - 1 simples Shelf kit - 1 double Kit de étagère - 1 double Set Regalaufsatz - 1 Doppelregal.</p> <p>PI 320 >> CEP 1.5 VCI PI 325 >> CEP 2 VCI</p>	<p>Kit prateleira - 1 dupla Shelf kit - 1 double Kit de étagère - 1 double Set Regalaufsatz - 1 Einfachregal.</p> <p>PI 311 >> CEP 1.5 VCI PI 315 >> CEP 2 VCI</p>	<p>Kit de união Union kit Kit d'union Abdeckung.</p> <p>PI 310 >> CEP 1.5 PI 335 >> CEP 2</p>	<p>Cesto, cuba e divisória de cesto Panier, cuve e séparateur de panier Korb, Kunststoffbehälter, Trenngitter für Korb</p> <p>AR 032 / PL 155 / AR 085 >> CEP 1.5 / CEP 2.0</p>	<p>Perfil expositor de preços Ticket strip Porte-prix Preisauszeichnungsleiste</p> <p>PI 100 >> CEP 1.5 PI 110 >> CEP 2.0</p>
	<p>REF: AR 091</p> 	<p>REF: AR 092</p> 	<p>REF: AR 093</p> 	<p>REF: AR 089</p> 	<p>REF: AR 088</p> 	<p>REF: AR 110</p> 
<p>Descrição Description Description Beschreibung</p> <p>REF/Modelo compatível REF/Compatible model REF / Modèle compatible REF / kompatibles Modell</p>	<p>Divisória Divider Séparateur Trenngitter</p> <p>AR 091 >> CEP 1.5 \ CEP 2.0</p>	<p>Divisória Divider Séparateur Trenngitter</p> <p>AR 092 >> CEP 2.0</p>	<p>Divisória Divider Séparateur Trenngitter</p> <p>AR 093 >> CEP 1.5 \ CEP 2.0</p>	<p>Divisória baixa Low divider Séparateur bas Kleines Trenngitter</p> <p>AR 089 >> CEP 1.5 \ CEP 2.0</p>	<p>Divisória alta High divider Séparateur haut Großes Trenngitter</p> <p>AR 088 >> CEP 1.5 \ CEP 2.0</p>	<p>Divisória Divider Séparateur Trenngitter</p> <p>AR 110 >> CEP Topo</p>

REF: PI 800 / PI 801 / PI 804



Kit de iluminação LED
LED kit
Eclairage LED
LED Beleuchtungsset.

PI 800 >> CEP 1.5
PI 801 >> CEP 2.0
PI 804 >> CEP TOPO



Accessórios

Accessories / Accessoires / Zubehör

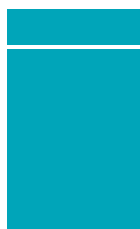

Descrição
Description
Description
Beschreibung



**Kit prateleira - 1 dupla /
Shelf kit - 1 double /
Kit de étagère - 1 double /
Set Regalaufsatz - 1 Doppelregal.**

**Kit prateleira 1 simples /
Shelf kit - 1 single /
Kit de étagère - 1 simple /
Set Regalaufsatz - 1 Einfachregal.**

**Kit de união /
Union kit /
Kit d'union /
Abdeckung.**

**Kit de prateleira - 2 simples
Shelf kit - 2 single
Kit de étagère - 2 simple
Set Regalaufsatz - 2 Einfachregale**

**Kit de prateleira - 2 duplas /
Shelf kit - 2 double /
Kit de étagère - 2 double /
Set Regalaufsatz - 2 Doppelregale.**

**Cesto /
Basket /
Panier /
Korb.**

REF/Modelo compatível
REF/Compatible model
REF / Modèle compatible
REF / kompatibles Modell

PI 326 >> Panorâmica 2

PI 319 >> Panorâmica 2

PI 333 >> Panorâmica 2

PI 340 >> Panorâmica 2

PI 323 >> Panorâmica 2

AR 055 >> Panorâmica

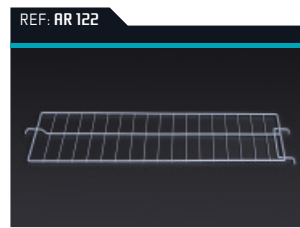
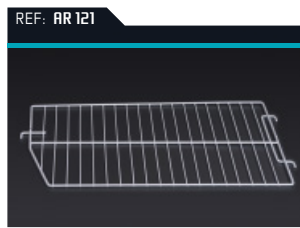
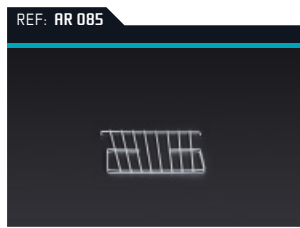

Descrição
Description
Description
Beschreibung



**Divisória de cesto /
Basket divider /
Séparateur pour panier /
Trenngitter für Korb.**

**Divisória /
Divider /
Séparateur /
Trenngitter.**

**Divisória /
Divider /
Séparateur /
Trenngitter.**

**Perfil expositor de preços /
Ticket strip /
Porte-prix /
Preisauszeichnungsleiste.**

**Perfil expositor de preços /
Ticket strip /
Porte-prix /
Preisauszeichnungsleiste.**

**Kit de iluminação LED /
LED kit /
Eclairage LED /
LED Beleuchtungsset.**

REF/Modelo compatível
REF/Compatible model
REF / Modèle compatible
REF / kompatibles Modell

AR 085 >> AR 050 / AR 070 / AR 080

AR 121 >> PANORÂMICA 2

AR 122 >> PANORÂMICA TOPO

PI 105 >> PANORÂMICA 2.0

PI 108 >> PANORÂMICA TOPO

PI 801 >> PANORÂMICA 2
PI 804 >> PANORÂMICA TOPO



Accessórios

Accessories / Accessoires / Zubehör

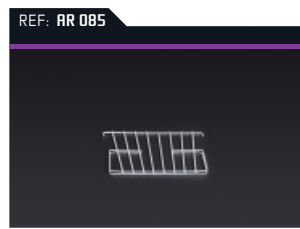
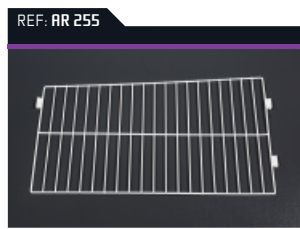
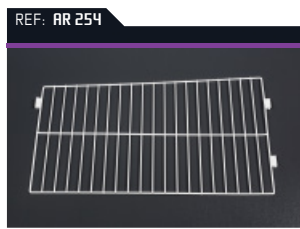
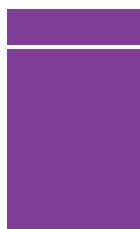

Descrição
Description
Description
Beschreibung



Divisória
Divider
Séparateur
Trenngitter.

Divisória
Divider
Séparateur
Trenngitter.

Cesto
Basket
Panier
Korb.

Divisória de cesto
Basket divider
Séparateur pour panier
Trenngitter für Korb.

Perfil expositor de preços
Ticket strip
Porte-prix
Preisauzeichnungsleiste.

Perfil duplo de expositor de preços
Double picket strip
Doble porte-prix
Preisauzeichnungsleiste.

REF/Modelo compatível
REF/Compatible model
REF / Modèle compatible
REF / kompatibles Modell

AR 254 >> Super 1.5 / Super 2.0 / Super 2.5

AR 255 >> Super TOPO

AR 055 >> SUPER

AR 085 >> AR 050 / AR 070 / AR 080

PI 109 >> Super 1.5
PI 105 >> Super 2
PI 104 >> Super 2.5

PI 119 >> Super 1.5
PI 117 >> Super 2.0
PI 107 >> Super 2.5
PI 118 >> Super topo

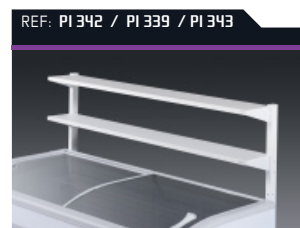

Descrição
Description
Description
Beschreibung



Kit prateleira - 1 dupla
Shelf kit - 1 double
Kit de étagère - 1 double
Set Regalaufsatz - 1 Doppelregal.

Kit prateleira 1 simples
Shelf kit 1 single
Kit de étagère - 1 simple
Set Regalaufsatz - 1 Einfachregal.

Kit de união
Union kit
Kit d'union
Abdeckung.

Kit de prateleira - 2 simples
Shelf kit - 2 single
Kit de étagère - 2 simple
Set Regalaufsatz - 2 Einfachregale.

Kit de prateleira - 2 duplas
Shelf kit - 2 double
Kit de étagère - 2 double
Set Regalaufsatz - 2 Doppelregale

Rodapé
Skirting
Plithes
Wasserschutzleisten.

REF/Modelo compatível
REF/Compatible model
REF / Modèle compatible
REF / kompatibles Modell

PI 316 >> Super 1.5
PI 328 >> Super 2
PI 324 >> Super 2.5

PI 312 >> Super 1.5
PI 318 >> Super 2
PI 309 >> Super 2.5

PI 332 >> Super 1.5
PI 334 >> Super 2
PI 331 >> Super 2.5

PI 342 >> Super 1.5
PI 339 >> Super 2
PI 343 >> Super 2.5

PI 314 >> Super 1.5
PI 322 >> Super 2
PI 329 >> Super 2.5

PI 350 >> Super 1.5
PI 351 >> Super 2.0
PI 354 >> Super 2.5
PI 352 >> Super.TOPO

REF: PI 108



Perfil expositor de preços
Ticket strip
Porte-prix
Preisauszeichnungsleiste.

PI 108 >> Super TOPO

REF: PI 802 / PI 804

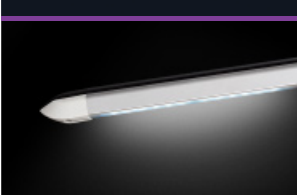

Kit de iluminação LED
LED kit
Eclairage LED
LED Beleuchtungsset.

PI 800 >> Super 1.5
PI 801 >> Super 2.
PI 802 >> Super 2.5
PI 804 >> Super TOPO

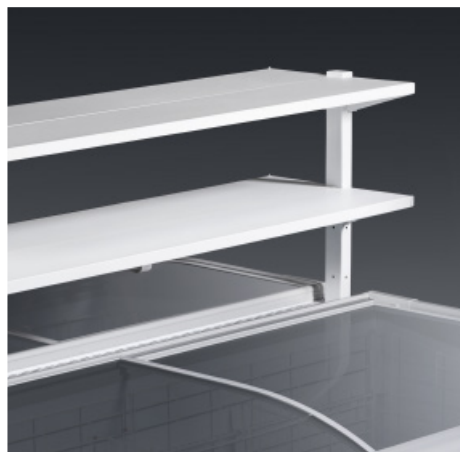

Accessórios

Accessories / Accessoires / Zubehör



REF: AR 211



REF: PI 127



REF: PI 128



REF: PI 344

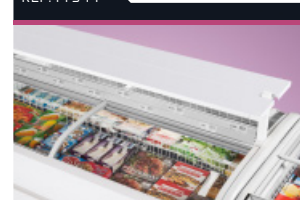

Descrição
Description
Description
Beschreibung



**Divisória /
Divider /
Séparateur /
Trenngitter.**

REF/Modelo compatível
REF/Compatible model
REF / Modèle compatible
REF / kompatibles Modell

AR 211 >> DUPLA 2.2

**Perfil expositor de preços /
Ticket strip /
Porte-prix /
Preisauszeichnungsleiste.**

PI 127 >> DUPLA 2.2

**Perfil expositor de preços /
Ticket strip /
Porte-prix /
Preisauszeichnungsleiste.**

PI 128 >> DUPLA TOPO

**Kit prateleira
Shelf kit /
Kit de étagère /
Set Regalaufsatz.**

PI 344 >> DUPLA 2.2

REF: AR 214



REF: AR 213



REF: AR 215



REF: AR 216



Descrição
Description
Description
Beschreibung



**Divisória baixa /
Low divider /
Séparateur bas /
Kleines Trenngitter /**

REF/Modelo compatível
REF/Compatible model
REF / Modèle compatible
REF / kompatibles Modell

AR 214 >> DUPLA TOPO

**Divisória alta /
High divider /
Séparateur haut /
Großes trenngitter /**

AR 213 >> DUPLA TOPO

**Divisória de fundo/
Bottom grid /
Grille de fond /
Großes Bodengitter /**

AR 215 >> DUPLA TOPO

**Grilha de fundo /
Bottom grid /
Grille de fond /
Kleines Bodengitter /**

AR 216 >> DUPLA TOPO





ICONOGRAFIA

ICONOGRAPHY / ICONOGRAPHY / IKONOGRAFIE

1

Análise de perigo e pontos críticos de controle.

Hazard analysis and critical control points.
Descripción de los símbolos que aparecen
Description des symboles affichés

2

Segurança eléctrica.

Safety Household.
Descripción de los símbolos que aparecen
Description des symboles affichés

3

Norma particular para aparelhos de refrigeração comercial.

Particular requirement to comercial refrigerating appliances.
Descripción de los símbolos que aparecen
Description des symboles affichés



Conformidade Europeia
European conformity
Conformité Européene
Europäische Konformität

4

Medição de campos magnéticos

Measure of magnetic field.
Descripción de los símbolos que aparecen
Description des symboles affichés



Produto certificado
Certified product
Produit certifié
Zertifiziertes Produkt

5

Compatibilidade electromagnética.

Electromagnetic compatibility.
Descripción de los símbolos que aparecen
Description des symboles affichés



Programa de reconhecimento internacional de ensaios (IEC)
International recognition tests program (IEC)
Programme international de reconnaissance d'essais (IEC)
Internationales Prüfanerkennungsprogramm



Classe de temperatura [-15/-18] de acordo com classe de ensaio [25°C,60%HR]
Class temperature [-15/-18] according to test class [25°C, 60%HR]
Classe de température [-15/-18] d'accord classe d'essais [25°C, 60%HR]
Temperaturklasse [-15/-18] nach Prüfklasse [25°C, 60%HR]

6

Emissões de harmónicos

Harmonic emissions.
Descripción de los símbolos que aparecen
Description des symboles affichés



Directiva de restrição de substâncias perigosas
Restriction of hazardous substances directive
Directive de limitation de substances dangereuses
Richtlinie zur Beschränkung der Verwendung gefährlicher Stoffe



Classe de temperatura [+5/-1] de acordo com classe de ensaio [25°C,60%HR]
Class temperature [+5/-1] according to test class [25°C, 60%HR]
Classe de température [+5/-1] d'accord classe d'essais [25°C, 60%HR]
Temperaturklasse [+5/-1] nach Prüfklasse [25°C, 60%HR]

7

Classificação procedimentos e condições de teste para aparelhos de refrigeração

Refrigerated display cabinets, classification requirements and test conditions.
Descripción de los símbolos que aparecen
Description des symboles affichés



Sistema IEC de conformidade de ensaios e certificação de equipamento eléctrico e componentes
IEC system for conformity testing and certification of electrical equipment and components
Système IEC de conformité d'essais et certification d'équipements électriques et composants
IEC-Konformitätsprüfungs- und Zertifizierungssystem für elektrische Geräte und Komponenten



Rua do Lordelo 4510-591 Fânzeres - **PORTUGAL**
t: +351 22 489 68 20 / f: +351 22 489 88 77
arcaboa@arcaboa.com
www.arcaboa.com



FROZENFOOD

COOLWORK®



LINHA SUPERMERCADO / GAMME SUPERMARCHÉ
LÍNEA SUPERMERCADO © ARCABOA S.A. PORTUGAL